

SHURflo[®] Marine Grade Faucets

INSTALLATION INSTRUCTIONS

Your new SHURflo Marine Grade Faucet will give you years of trouble-free performance. Thank you for choosing SHURflo Marine Grade Faucets. Please read these instructions carefully before installing your new faucet. If you have any additional questions about the installation of this faucet, please feel free to contact one of our friendly customer service representatives at 1-800-854-3218.

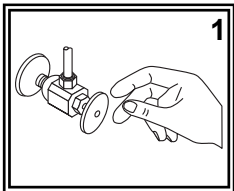

- (1) Turn off the water supply to your existing faucet (this procedure will vary depending on the specific plumbing system installed on your boat). Cover the sink drain to prevent any small parts or debris from falling in. Remove your existing faucet, taking care not to damage your existing water lines. Clean sink area in preparation for new faucet.

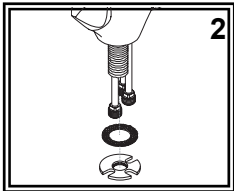

- (2) Remove the lock nut from the faucet by unscrewing the mounting tube. Remove rubber washer. Place your new faucet through the hole in your sink. Make sure the black gasket properly lines up with the bottom of the faucet. From under the sink, slide the rubber gasket back onto the mounting tube. Align the lock nut between the three (3) copper pipes and the mounting tube. Secure faucet by rotating the mounting tube from above the sink. Be careful not to scratch the finish on the head of the mounting tube when using a wrench. It may be necessary to re-adjust the faucet position by slightly loosening the lock nut, adjusting to the desired location, then re-tightening the lock nut.

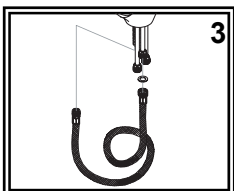

- (3) Connect sprayer hose to center copper pipe. Wrap the brass fitting on the center pipe with Teflon (Plumber's) tape. You may need to gently bend the copper pipes out from each other slightly to allow for hose fitting to rotate. From under the sink, insert the male end of the hose up through the mounting tube and out the top of the faucet.

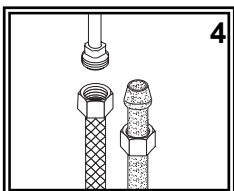

- (4) Connect water supply lines (not provided) to the connector hoses. Wrap the brass fittings on the inlet tubes with Teflon (Plumber's) tape. You may need to gently bend the copper pipes out from each other slightly to allow for hose fittings to rotate. Follow the appropriate steps depending on your water supply lines. If you have pre-assembled water supply hoses with threaded connectors, simply screw on supply lines. If you have plastic water lines with formed ends, water lines will seat partially up into the brass fittings. Connect by tightening the coupling nuts. We do NOT suggest using sweat fittings as they are prone to blow-outs.

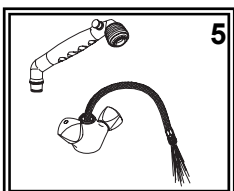

- (5) Before attaching the sprayer, pull the hose partially out and aim it down into the sink. Turn the water supply back on and allow both hot and cold water to run for at least one full minute without the sprayer. While water is running, check all connections for leaks. Attach sprayer to the hose. Connections may need re-tightening.

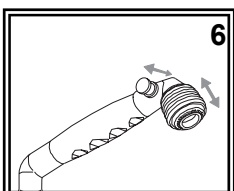

- (6) To switch from normal aerate to spray, simply pull down on the chrome ring around the aerator. Push it back up to switch back to aerate from spray. To set the faucet to "stand-by" push the stand-by button on the head of the sprayer. Push the button on the opposite side of the sprayer to allow water to flow. **NOTE: "STAND-BY" WILL ALLOW A SMALL AMOUNT OF WATER TO CONTINUE TO TRICKLE OUT OF THE SPRAYER.**

Parts

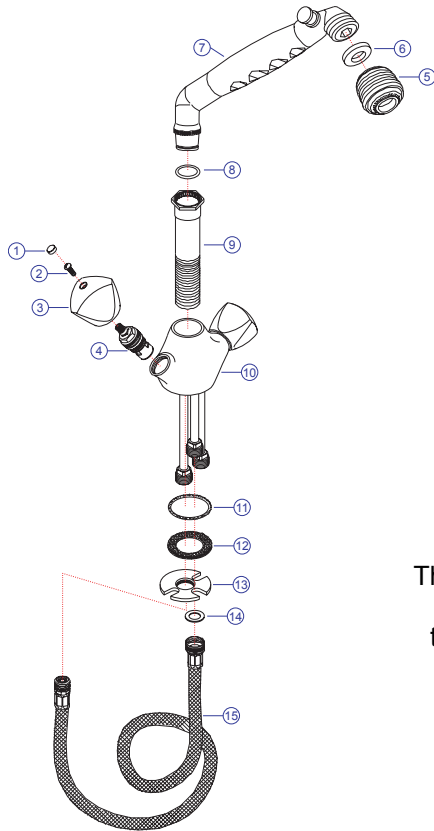

- 1) Blue/Red Cap
- 2) Handle Screw
- 3) Trinidad Handle
- 4) Ceramic Disc Cartridge
- 5) Aerator / Sprayer
- 6) Washer
- 7) Classic Sprayer
- 8) O-Rings
- 9) Mounting Tube
- 10) Body
- 11) Gasket
- 12) Washer
- 13) Lock Nut
- 14) Hose Washer
- 15) Hose

The matching optional Bulk Head Bracket is available through your retailer. Ask for 131-0212-CP

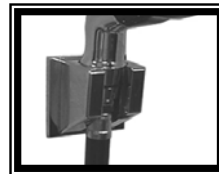

PROPER FINISH CARE:

Your new faucet is protected by a clear-coat. To clean it, you only need to wipe it with a damp, soft cloth. NEVER use any abrasive cleaners, steel wool, or chemicals, as they will harm the finish and void your warranty. If the faucet will be installed in a salt-air environment (boat exterior), regular cleaning with gentle soap and carnauba wax will prolong the life of the finish.

LIMITED WARRANTY

SHURflo Marine Grade Faucets & Accessories are guaranteed to be free from material and workmanship defects under normal use and service for a period of five (5) years from the date of purchase. This limited warranty will not apply to faucets or accessories that were improperly installed, misapplied, or incompatible with components not manufactured by SHURflo. Faucet failure due to foreign debris is not covered under the terms of this limited warranty. SHURflo will not warrant any faucet that is physically damaged or altered outside the SHURflo factory. Warranty claims may be resolved by a SHURflo service center. All returns are to be shipped with charges pre-paid. Package all returns carefully. SHURflo will not be responsible for freight damage incurred during shipping to a service center. SHURflo's obligation under this warranty policy is limited to the repair or replacement of the faucets & accessories. Faucets or accessories found not defective (under the terms of this limited warranty) are subject to charges to be paid by the returnee for the testing and packaging of "tested good" units. Warranty returns will be shipped on a freight allowed basis. SHURflo reserves the right to choose the method of transportation. SHURflo is not responsible nor will it reimburse for labor necessary to remove and reinstall a faucet or accessory if found defective. This warranty is only a representation of the complete Marine Products Limited Warranty outlined by Service Bulletin #1050.

**SHURflo reserves the right to update specifications, prices, or make substitutions.*



SHURflo*
5900-A Katella Ave.
Cypress, CA 90630
(562) 795-5200 (800) 854-3218
FAX (562) 795-7564
Shipping: 5900-C Katella Ave.
Cypress, CA 90630

SHURflo East
52748 Park Six Court
Elkhart, IN 46514-5427
(574) 262-0478 (800) 762-8094
FAX (574) 264-2169
<http://www.shurflo.com>

SHURflo Ltd.*
Unit 5 Sterling Park
Gatwick Road, Crawley
West Sussex, RH10 2QT
United Kingdom
+44 1293 424000
FAX +44 1293 421880

